

Article number: 20141B48B482SW

Description: E+G two-way connecting clamp  
GN141-B48-B48-2-SW

## Measures

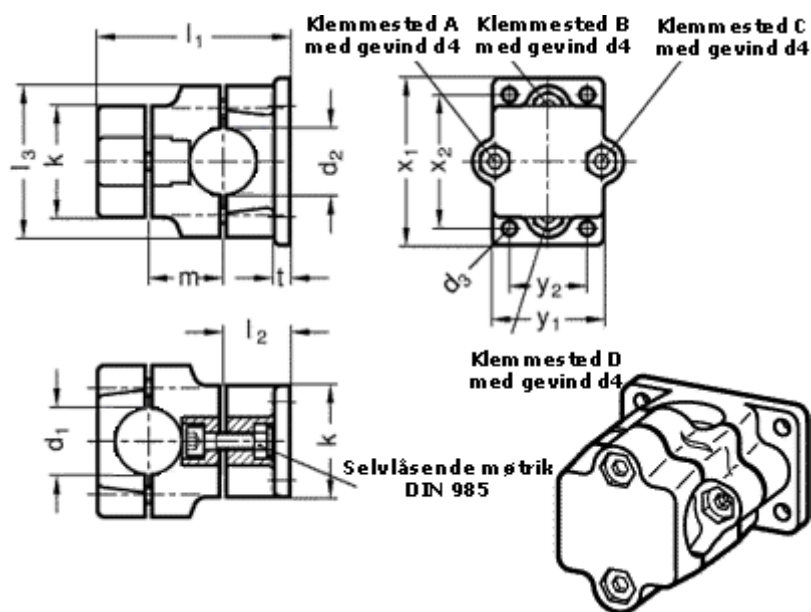

Adjustable clamp lever = GN 911-M10-63 have to be ordred separately

d1	= 48
d2	= 48
d3	= 11
d4	= M10
k	= 76
l1	= 136
l2	= 46

l3	= 98
m	= 55
t	= 14
x1	= 115
x2	= 90
y1	= 76
y2	= 50